



ICON PEB STEEL (BD) LTD.

PRE-FABRICATED STEEL BUILDING MANUFACTURER

**SAFETY
ECONOMY
SUSTAINABILITY**

MESSAGE FROM MANAGING DIRECTOR

Assalamu Alaikum,

Icon Peb Steel (BD) Ltd. As the name implies is a modern and state of the art Pre-Engineered Steel Fabrication and Construction Company.

The company was started by a core group of highly experienced team of engineers who felt that the existing companies were not doing justice to the comparatively new industry. We provide to deliver quality buildings at competitive prices and within a short period of 7 years, we have carved out a niche in the market.



Our motto has been and will be Quality, Timely delivery and price. To the motto, I want to add, ethical way to doing business. On behalf of the Board of Directors and myself, I take this opportunity to present our company and our capabilities for your consideration. Bangladesh has a vibrant economic with a huge potential for growth. We want to contribute to that growth. I wish our old and new clients, our well-wishers, our business partners, our suppliers, Bankers, and most importantly our officers and workers my sincerest gratitude for their contribution to our success and hope our friendly relationship will grow further and will contribute to our mutual benefit in the days and years to come.

We are looking forward to our customers' valued order and we promise highest quality, at a competitive price, quick delivery and effective after sales service such that we can expect

Thank you

A handwritten signature in black ink, appearing to be 'Y. Khan'.

Engr. Younus Khan
Managing Director
Icon Peb Steel (BD) Ltd



Advantages of Steel Structure

Reduced Construction Time

"It can reduce total construction time on a project by at least 50% of conventional construction time. This will allow faster occupancy and earlier realization of revenue."

Design

"Since PEB's are mainly form of standard sections and connections, the design time has been significantly reduced. Specialized computer analysis and design programs optimizes material requirement."

Lower Cost

"Due to the systems approach, there is a significant saving in design, manufacturing and site erection cost. The structural elements are shaped to follow the stress diagram of the member, thus reducing weight, cost and load to foundations."

Foundations

"PEB are about 30% lighter than the conventional structures. Hence, the foundations are of simple design, easy to construct and lighter weights."

Quality Control

"As buildings are being manufactured completely in the factory under controlled conditions, the quality is assured."

Large Clear Spans

"Buildings can be supplied to around 90M clear spans."

OUR STRENGTH

- No compromise with quality.
- Best Possible Product
- Professional Sales & Customer Service
- Expertise in Engineering
- Excellence in Co-ordination and Team work



OUR EXPERTISE.

- Industrial Building & Shed.
- Multi-storied Steel Building.
- Garments Factory.
- Showrooms & Rack Structures.
- Filling Station.
- Commercial Building
- Paper Mills.
- Textile & Spinning Mills.
- Shopping Mall
- Auto Rice Mills.
- Stadium.
- Bridge.
- Power station

DESIGN CODE

The buildings are designed in accordance with the following codes :

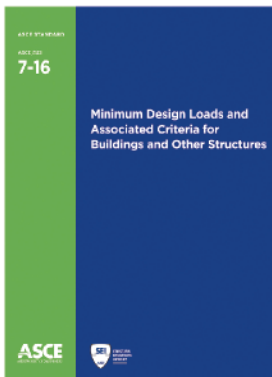
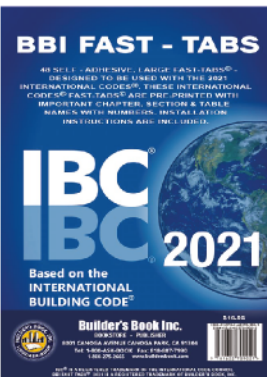
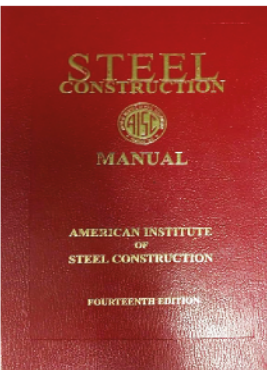
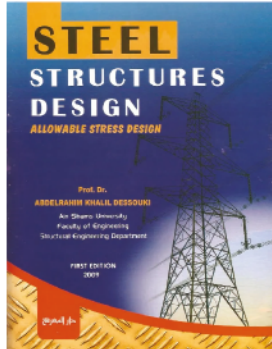
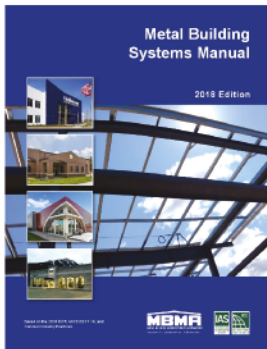

A. Load are Applied in Accordance with :

- ⊙ BNBC-2020 (Bangladesh National Building Codes)
- ⊙ MBMA-2005 (Metal Building Manufacturers Association)
- ⊙ IBC-2009 (International Building Code)
- ⊙ ASCE-7-05 (American Society of Civil Engineers)

B. Hot Rolled and built-up Sections are designed in accordance with :

- ⊙ American Institute of Steel Construction (AISC)
 - * Steel Construction Manual
 - * Design Guide
 - * ASD and LRFD Method

C. Cold-formed members are desinged in accordance with

- ⊙ AISI- (American Iron and Steel Institute)

D. Welding is applied in accordance with :

- ⊙ AWS- (American Welding Society)

E. Structural Analysis, Design and detailing is done by the aid of following softwares :

- ⊙ STAAD Pro.
- ⊙ ETABS
- ⊙ SAP
- ⊙ 3D Studio Max
- ⊙ Autodesk Revit
- ⊙ Sकेetchup
- ⊙ CorelDraw
- ⊙ TEKLA Structures
- ⊙ Auto CAD
- ⊙ Micro Station

M.S Plate

MATERIAL SPECIFICATIONS

Parameter		Min.mm	Max.mm
Flange	Width (B)	100	600
	Thickness (TF)	6	40
Web	Height (H)	100	1500
	Thickness (TW)	4.5	32
CP	Thickness (T)	12	70

Material : Hot Rolled Plates
 Standard : ASTM A572 M Grade-50 (G-345)
 Yield Strength : 345 Mpa
 Surface : Red Oxide/Gray Oxide
 Length : 6M/20 ft
 Application : Column, Beam, Rafter, Bracing etc.

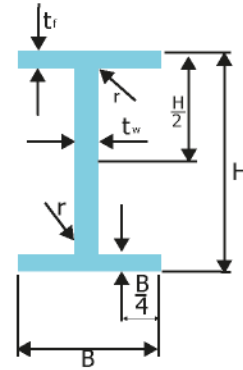

H-Beam Specification	
Material	Build Up Section
Standard	ASTM A572 M Grade-50 (G-345)
Yield Strength	345 Mpa
Yimate Strength	450 Mpa



Hot Rolled Strip
(by Gas Cutting or Sher Cutting)

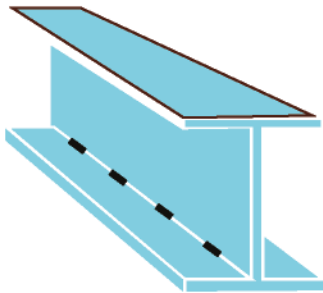

H-beam Assembling
(by auto Spot Welding)

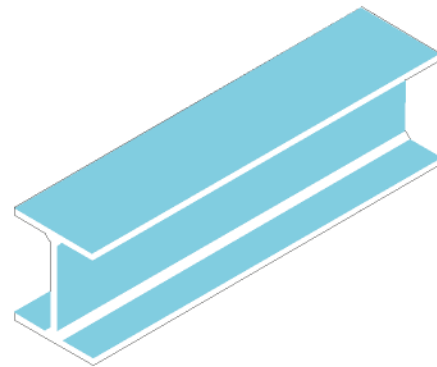

H-Beam Section

Geometrical moment of Inertia $I = Ar^2$
 Radius of gyration of Area $r = \sqrt{I/A}$
 Modulus of section $Z = I/Y$
 (A = Section Area)

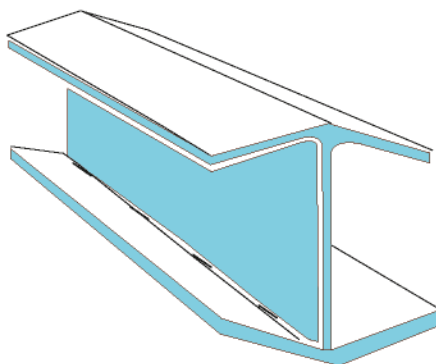

H-beam Fabrication Straighten
(by submerge arc welding)

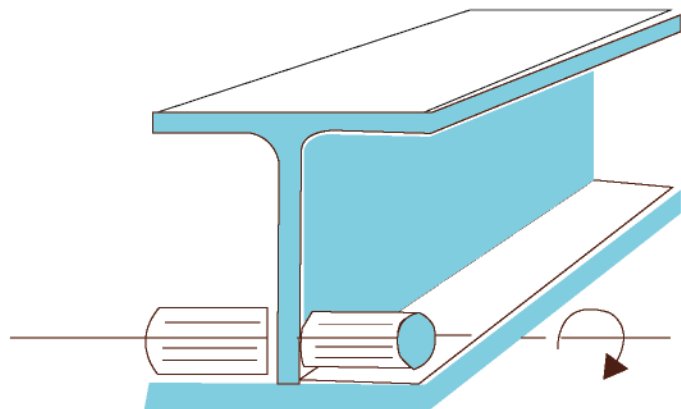

STRUCTURAL ACCESSORIES



Anchor Bolts



Color Coated Sheet

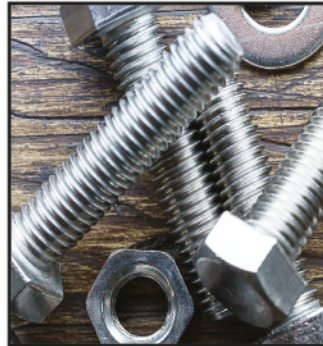

Nut Bolt



Fasteners



Wire Clip



Turn Buckle



Cable



Washer



Royal Bolts



Sag Rod

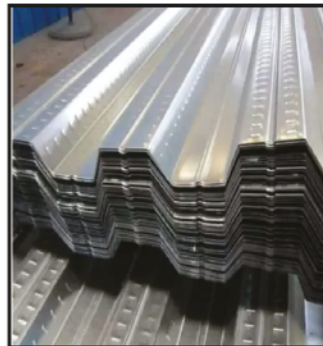

Decking Panel

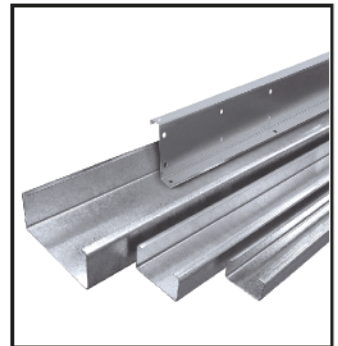

Purlin



Cheaker Plate



Chemical Bolt



Natural Ventilation



Louver System

SHEETING ACCESSORIES



Roof Monitor



Gravity Ventilator



Ridge Cap

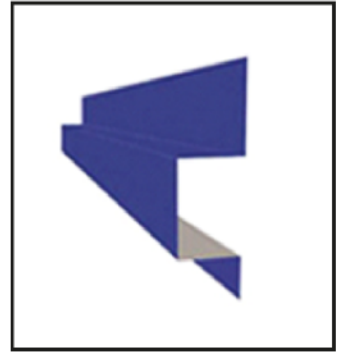

Bottom Flashing



Bubble Insulation



PE-Foam Insulation

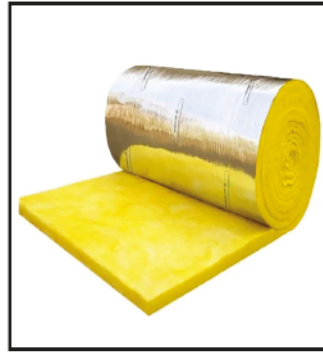

Glass Wool Insulation



Rock Wool Insulation

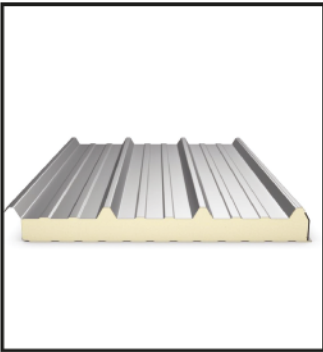

Sandwich Panel

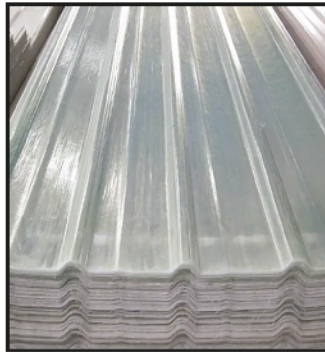

Sky Light Sheet



Exhaust Fan



Rain Water Pipe



Canopy System



Sliding Door System



Roller Shutter



Louver System

Our Factory



Factory Shed Outer View



Factory Inner View

Factory Machineries



AUTO WELDING SAW MACHINE



MIG WELDING MACHINE

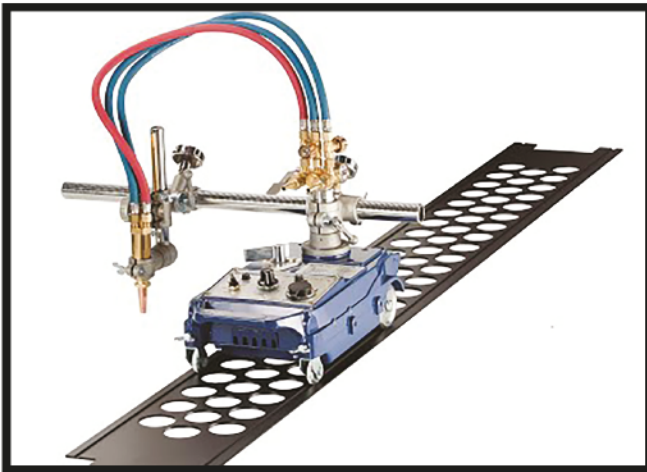

Auto Cutting Machine



Hydraulic Drill Machine



Gach Drill Machine



Magnetic Drill Machine

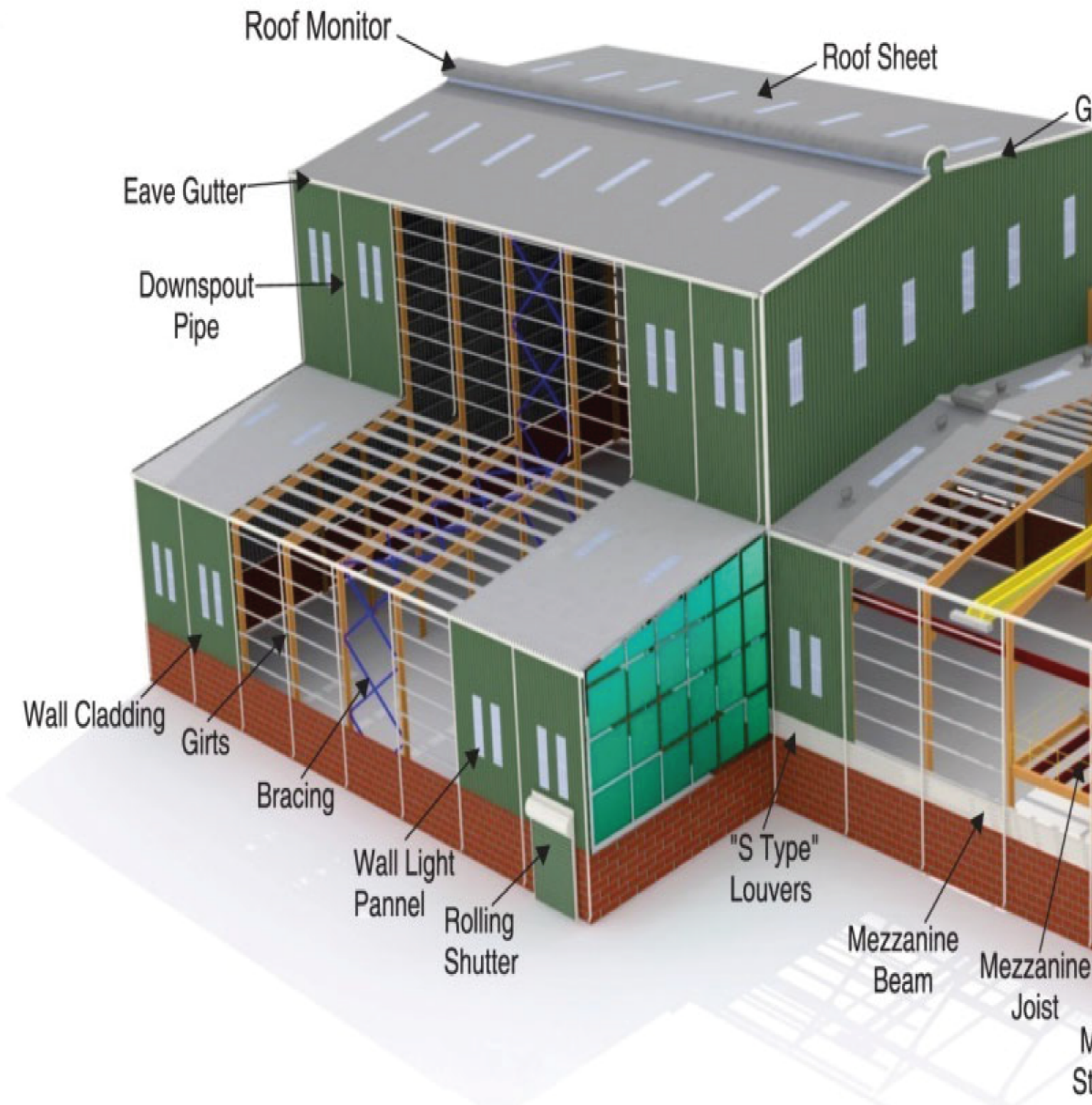

STEEL BUILDING SYSTEM

able Trim

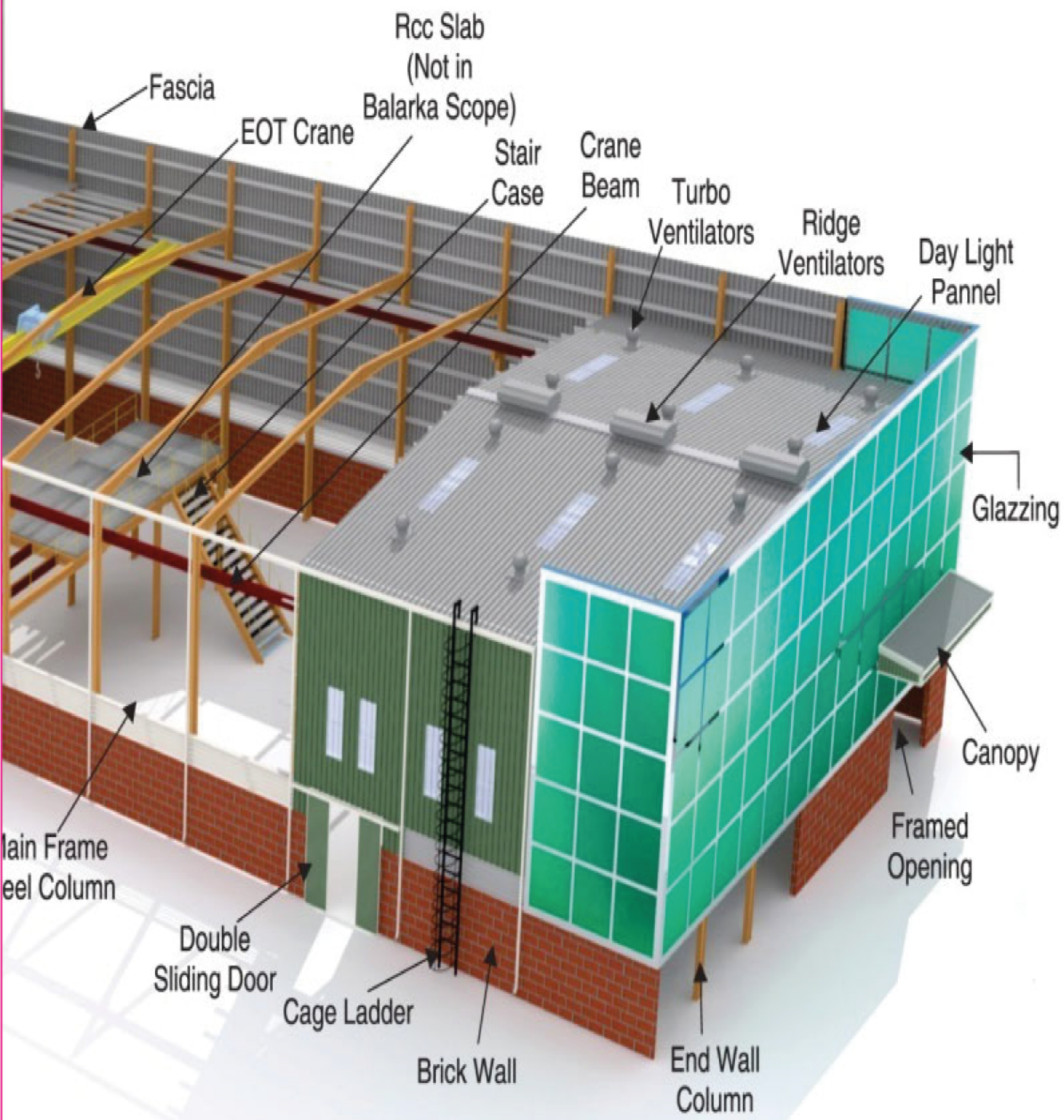

PROJECTS



Anan Chemical Industries Ltd., Singair, Manikganj.



Meghna Innova Rubber Co. Ltd., Mirzapur, Tangail.



EH Enterprise., Birulia, Savar, Dhaka.



Soudagor Express Ltd., Keraniganj, Dhaka.



Lipy Paper Mills Ltd., Sonargaon, Narayanganj.



Agata Feed Mills Ltd., Chandina, Cumilla.



PROJECTS



Poly Cable Industries Ltd., Munshiganj.



SR Chemical Industries Ltd., Serajganj.



Smart Group (Sony Warehouse), Keraniganj



Habib Paper Mills Limited, Rupgonj, Narayanganj.



Village Agro Meat Industries (Cold Storage), ,Saltaha, Faridpur.



Tex Zippers (BD) Ltd. (Zipper Unit), Adamjee EPZ, Narayanganj.

PROJECTS



Irfan Market, New Market, Khulna.



Irfan Market, New Market, Khulna.



Robin Printing & Packages Ltd., Sreepur, Gazipur.



Robin Printing & Packages Ltd., Sreepur, Gazipur.



Western Technical Training Institute, Sirajdikhan, Munshigonj.



Western Technical Training Institute, Sirajdikhan, Munshigonj.



PROJECTS



Metro Food & Beverage Ltd., Beribadh, Mirpur, Dhaka.



Metro Express Courier Services, Hemayetpur, Savar, Dhaka.



Lipy Paper Mills Limited (Sheet Cutter), Sonargaon, Narayangonj.



Smart Group (Vivo), Narayangonj.



RAS Cement industries Ltd, Konabari, Gazipur.



Audi Service Center, Chauddagam, Cumilla.



PROJECTS



Nilima Bag Mills Ltd., Singair, Manikganj.



Royal Toiletries Ltd., Sonargaon, Narayangonj.



Halima Coatge (Duplex House), Saltha, Faridpur.



Mondol Tower., Jhiltuli, Faridpur.



Pasha Group, Sonargaon, Narayangonj.



Pasha Group, Sonargaon, Narayangonj.



Some of Our Valued Clients

Garments Industries :

Tex Zippers (BD) Ltd. (Button Unit)	Adomjee EPZ , Narayanganj	46,800
Nilima Bag Industries Ltd.	Singair, Manikganj	40,000
Zaynab Textile Mills Ltd.	Pubail, Gazipur.	20,000
Texway Apparels Ltd.	Hotapara, Gazipur.	30,000
Chowdhury Knitwear Ltd.	Etakhola, Nasingdhi.	20,000
Ershad Knit Fashion Ltd.	Ashuila, Savar.	26,000
Tex Zippers (BD) Ltd. (Zippers Unit)	Adomjee EPZ , Narayanganj	1,12,000

Printing & Packaging :

Robin Printing & Packages Ltd.	Sreepur, Gazipur	62,000
Lecture Publication	Mautail, Dhaka	28,400
Premier Printing Press	Mautail, Dhaka	42,200
Dhaka Paper Products Ltd.	Demra, Dhaka.	1,98,000
MAB Paper Products	Sonargoan, Narayanganj.	1,24,800
Chittagonj Packages Ltd.	Nasirabad, Chittagonj.	1,34,400
Bodorbox Industries Ltd.	Nasirabad, Chittagonj.	1,28,800
Bayezid Packages Limited	Mawna, Gazipur.	1,16,200

Madrasha :

Jamtola Maditul Ulum Madrasha	Pirganj, Rangpur	48,800
Chauddagram MH Darul Ulum	Chauddagram, Cumilla.	28,800
Monpura Kasemul Ulum Madrarsha	Monpura, Bhola	16,800
Noraibagh Madrasha	Demra, Dhaka.	34,200
Anarapura Madrasha	Gazaria, Munshigonj.	20,000
Chauddagram T. Quran Madrasha	Gazaria, Munshigonj.	18,200

Food & Beverage :

Clients Name	Location	Project Size (sft)
Transcom Food & Beverage	Biruliya, Savar, Dhaka.	60,000
Golden Food Products	Pubail, Gazipur	12,000
Alishan Foods & Beverage Ltd.	Raniganj, Dinajpur	42,000
Coffee Lime	Khilgaon, Dhaka	6,000
Ujjal Flour Mills.	Demra , Dhaka	34,000
Metro Food & Beverage	Mirpur, Dhaka	82,000
EH Enterprise	Konabari, Gazipur	50,000
Ibra oill Mills Ltd.	Serpur, Bogura	26,000



Some of Our Valued Clients

Training Center :

Western Technical Training Institute	Serajdikhan, Munshiganj	20,000
Bashundhara Training & Test Center	Shekher Jayga, Khilgaon, Dhaka.	10,000
Bangladesh Signapore Training Center	Zirabo, Ashulia, Savar.	15,000

Real State :

Abed Holdings Limited	Purana Paltan, Dhaka	20 Storied Lift Core
Ideal Products	Nikunjo-01, Dhaka	7,000
Basic Builders Limited	Goran, Khilgoan, Dhaka.	5,200

Mosque :

Jamtola Madinatul Jame Mosque	Pirganj, Rangpur	24,000
Chauddagram MH Jame Mosque	Chauddagram, Cumilla.	12,800
Uttor Helepara Jame Mosque	Kaliganj, Jhenidha.	22,000
Anarpura Jame Mosque	Gazaria, Munshiganj	16,000
Jatiarkhil Jame Mosque	Chauddagram, Cumilla	20,800
Uttor Falgunkora Jame Mosque	Chauddagram, Cumilla	10,600

Paper Mills Industries :

Smart Group	Rupganj, Narayanganj	32,000
Poly Cable Industries Ltd.	Gazaria, Munshiganj	62,000
New Araf Enterprise	Saltha, Faridpur	12,000
NBR	Segunbagicha, Dhaka	6 Storied Lift Core
Metro Express Limited	Aminbazar, Dhaka.	72,600
RAS Cement Products Ltd.	Konabari, Gazipur	16,000
EH Enterprise Ltd.	Birulia, Savar, Dhaka.	62,000
SNS Market	New Market, Khulna	24,000
Anan Chemical Mills Ltd.	Singair, Manikganj	34,500
Steel King Industries	Targach, Gazipur	30,000
Dream Tower	Nasirabad, Chittagonj.	1,12,800
Eco Jute Process	Shahipur, Nilpharmi	1,16,800
Sugondha Tower	Nasirabad, Chittagonj.	1,42,200
Nurani Flour Mills	Hobiganj Sadar, Hobiganj,	2,21,600
MAA Tissue Paper Mills Ltd.	Feni Sadar, Feni.	2,88,800
Forid Products	Bhaluka, Mymensigh	82,000
Aziz Tower	Demra, Dhaka.	1,84,800



Our Valuable Client





**ICON PEB STEEL
(BD) LTD.**

PRE-FABRICATED STEEL BUILDING MANUFACTURER

Office Address:

772 (3rd Floor), Road-10
Section-06, DOHS
Mirpur, Dhaka
Cell: 01711876224
Email: younusiconsteel.bd@gmail.com

Factory:

84, Trimohoni, Madrasha
Road, Nandipara, Khilgaon,
Dhaka-1219
Bangladesh.

ICON PEB STEEL (BD) LTD.

PRE-FABRICATED STEEL BUILDING MANUFACTURER

“Good Quality Good Relationship”